

● OUTLINE DIMENSION

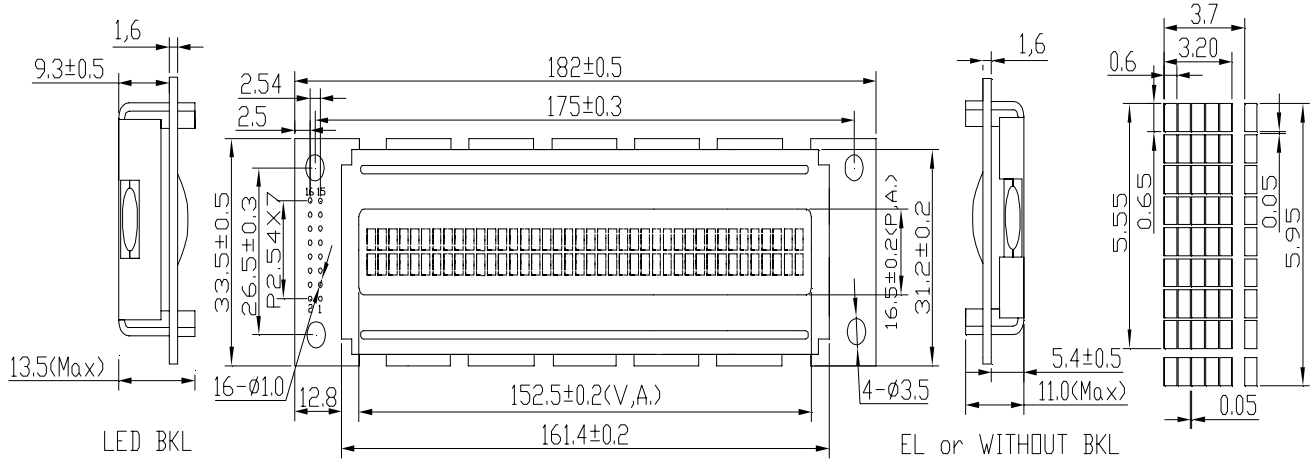

● BLOCK DIAGRAM & POWER SUPPLY

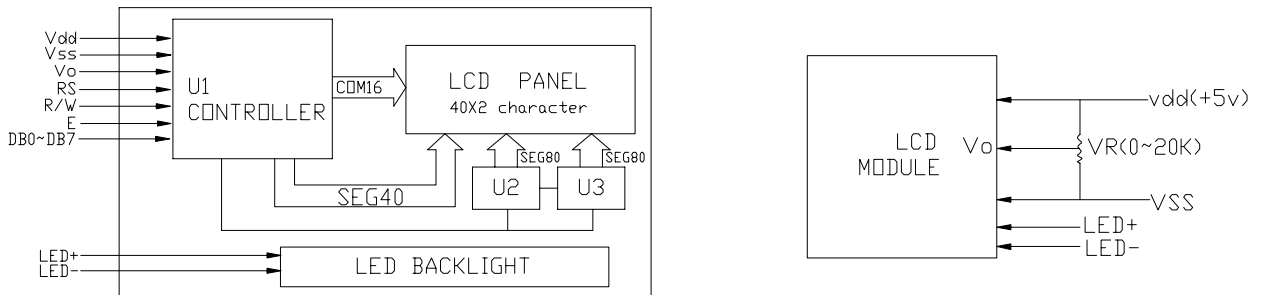

● MECHANICAL SPEC.&FEATURES

Item	Dimension(mm)
Module Size(WxHxT)	182.0x33.5x11.0/14.0
Viewing Area(WxH)	152.5x16.5
Dot Size(WxH)	0.60x0.65
Dot Pitch(WxH)	0.65x0.70
Character Size (WxH)	3.20x5.55
Character Pitch(WxH)	3.70x5.95

Features	
LC Fluid	STN(Yellow-green, Gray, Blue), FSTN
Polarizer	Reflective, Transflective, Transmissive
View Angle	6:00 o'clock or 12:00 o'clock
Display Type	Positive or Negative
Backlight	LED(Optional)
Operating Temp.	0°C ~ 50°C or -20°C ~ 70°C
Controller	S6A0069 or Equivalent

● INTERFACE PIN CONNECTIONS

Pin No.	Symbol	Function
1	Vss	Ground for logic
2	Vdd	Power supply for logic
3	Vo	Power supply for LCD
4	RS	Register selection(H:Data,L:Instruction)
5	R/W	Read/Write selection(H:R,L:W)

Pin No.	Symbol	Function
6	E	Enable signal
7~14	DB0~DB7	Data bus lines
15	A	BKL+
16	K	BKL-

● ELECTRICAL CHARACTERISTICS

Item	Symbol	Test Condition	Min	Typ.	Max.	Unit
Operating Voltage	Vdd	Ta=25°C	...	5.0	...	V
Operating Voltage for LCD	Vlcd	Ta=25°C	...	4.5	...	V
Supply Current	Idd	Ta=25°C, Vdd=5.0V	...	2.0	3.0	mA
Supply Voltage for LED	Vf	Ta=25°C, R=6.8Ω	...	4.2	...	V
Supply Current for LED	If	Ta=25°C, Vf=4.2V	...	280	...	mA