

## ● OUTLINE DIMENSION

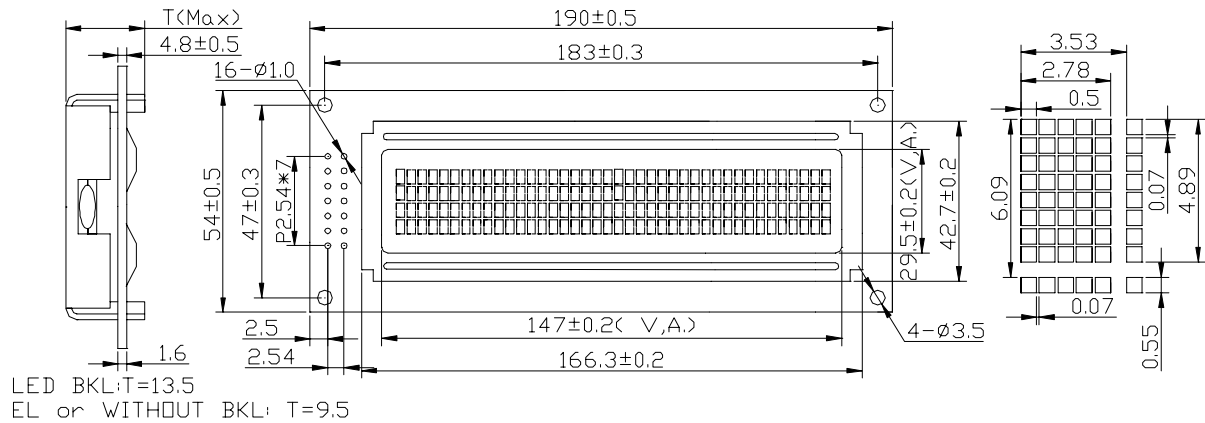

## ● BLOCK DIAGRAM & POWER SUPPLY

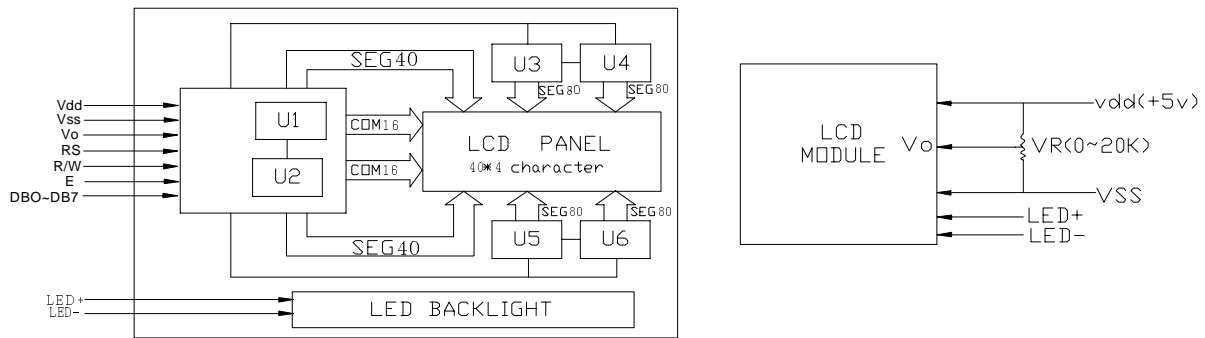

## ● MECHANICAL SPEC.&FEATURES

Item	Dimension(mm)
Module Size(WxHxT)	190.0x54.0x9.5/14.5
Viewing Area(WxH)	147.0x29.5
Dot Size(WxH)	0.50x0.55
Dot Pitch(WxH)	0.57x0.62
Character Size (WxH)	2.78x4.89
Character Pitch(WxH)	3.53x6.09

Features	
LC Fluid	STN(Yellow-green,Gray,Blue),FSTN
Polarizer	Reflective,Transflective,Transmissive
View Angle	6:00 o'clock or 12:00 o'clock
Display Type	Positive or Negative
Backlight	LED(Optional)
Operating Temp.	0°C ~ 50°C or -20°C ~ 70°C
Controller	S6A0069 or Equivalent

## ● INTERFACE PIN CONNECTIONS

Pin No.	Symbol	Function
1	Vss	Ground for logic
2	Vdd	Power supply for logic
3	Vo	Power supply for LCD
4	RS	Register selection(H:Data,L:Instruction)
5	R/W	Read/Write selection(H:R,L:W)

Pin No.	Symbol	Function
6	E	Enable signal
7~14	DB0~DB7	Data bus lines
15	A	BKL+
16	K	BKL-

## ● ELECTRICAL CHARACTERISTICS

Item	Symbol	Test Condition	Min	Typ.	Max.	Unit
Operating Voltage	Vdd	Ta=25°C	...	5.0	...	V
Operating Voltage for LCD	Vlcd	Ta=25°C	...	4.5	...	V
Supply Current	Idd	Ta=25°C, Vdd=5.0V	...	3.5	5.0	mA
Supply Voltage for LED	Vf	Ta=25°C, R=6.8Ω	...	4.2	...	V
Supply Current for LED	If	Ta=25°C, Vf=4.2V	...	340	...	mA